

ARTEMIS 2013 AIPP5

EMC²

**A Platform Project on Embedded Microcontrollers in
Applications of Mobility, Industry and the Internet of
Things**

May 26th, 2015, Paris, France
Werner Weber Infineon Technologies AG
Werner.Weber@infineon.com
+49 89 234 48470

... in cooperation with entire Project Management Team

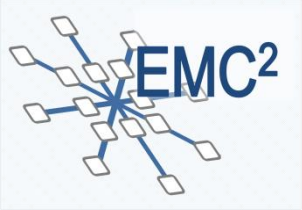

Motivation for EMC²



- Very fast technological advances of μ -electronics in past decades
- Amazing capabilities at lowered cost levels
- Today primarily exploited in consumer-oriented products
- Systems quickly put together since the next technology generation is already waiting around the corner
- Errors may be tolerated and a new execution attempt started
- This (and similar) way(s) of handling errors feasible for consumer products

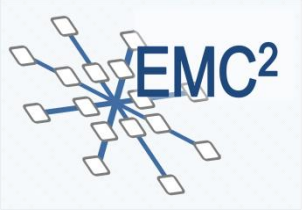

Motivation for EMC² (cont'd)



- In professional areas this simplistic approach is not feasible
 - Industrial production
 - Automotive
 - Avionics
 - Space
 - Systems with high data volume such as multi data centers
- Have to fulfill real-time safety requirements
- It is prime task of EMC² to bring those two worlds together
- Develop methods for safe use of modern embedded multicore controllers
- Help European industry to stay competitive

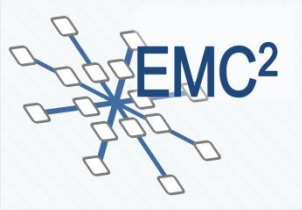

Project Overview Numbers



Embedded Multi-core Systems for Mixed-Criticality Applications in Dynamic and Changeable Real-Time Environments – EMC²

(Artemis Innovation Pilot Project (AIPP))

- AIPP 5: Computing Platforms for Embedded Systems
- Budget: 93.9 M€
- Funding: 15.7 M€ EU funding (Artemis)
26.7 M€ National funding
- Resources: 9636 person months (803 person years)
- Consortium: 99 Partners, 16 EU Countries + Israel

➔ **Largest ARTEMIS-JU project ever!**

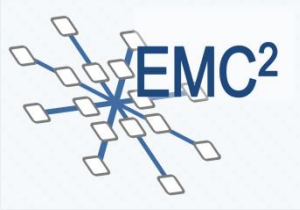

Project Overview

European Dimension



% of total costs per country

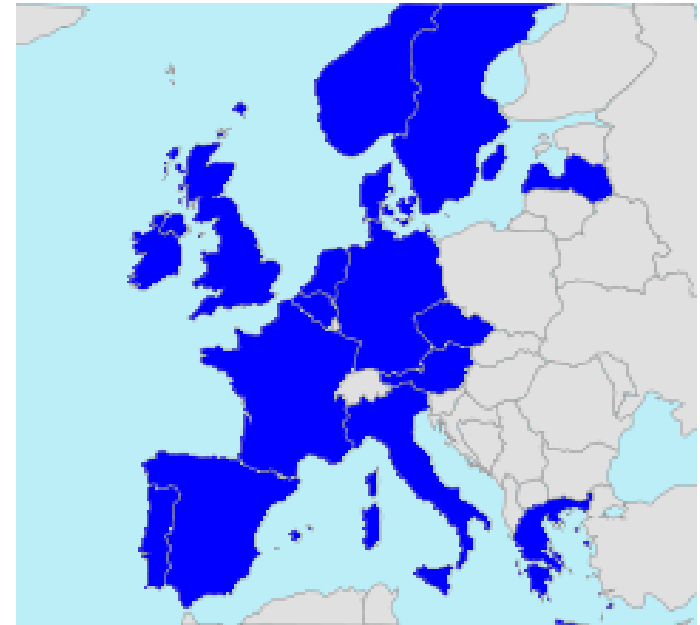
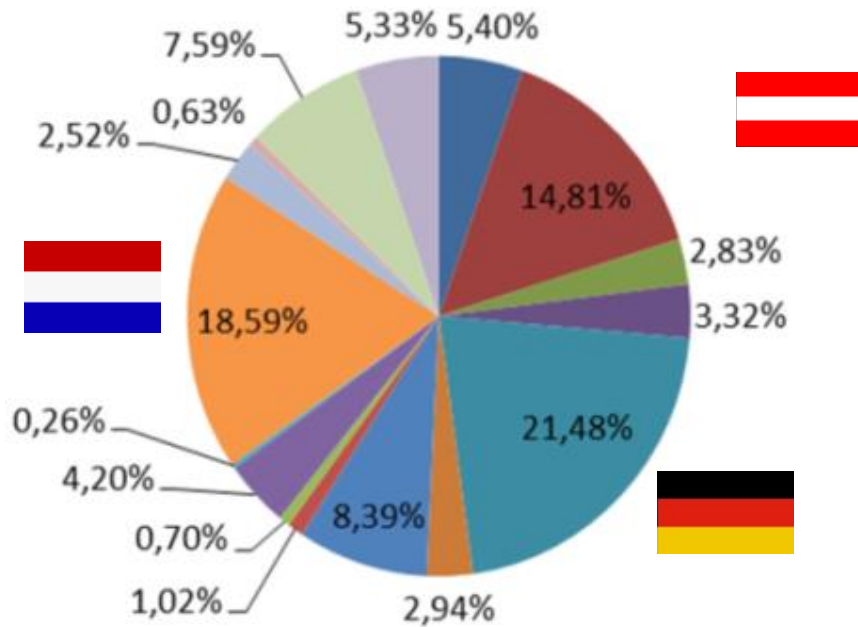

Country

- FR
- AT
- BE
- CZ
- DE
- DK
- ES
- GR
- IRL
- IT
- LAT
- NL
- NO
- PO
- SE
- UK



Reduce Number of Control Units Save cost and increase performance



Many heterogeneous single-core systems, specialized for the individual criticality levels

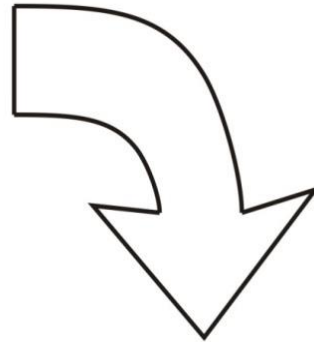
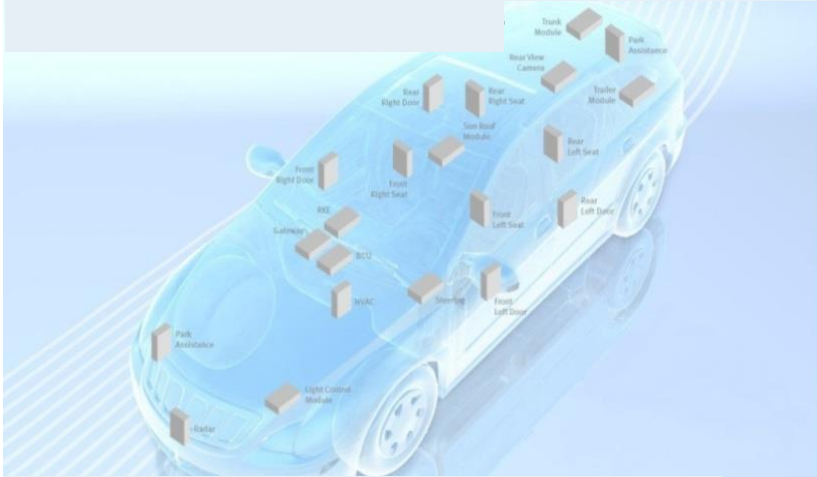

Vision

Aggregate resources
In multi/many cores,
ECU networks

Multi-core systems
for mixed criticalities

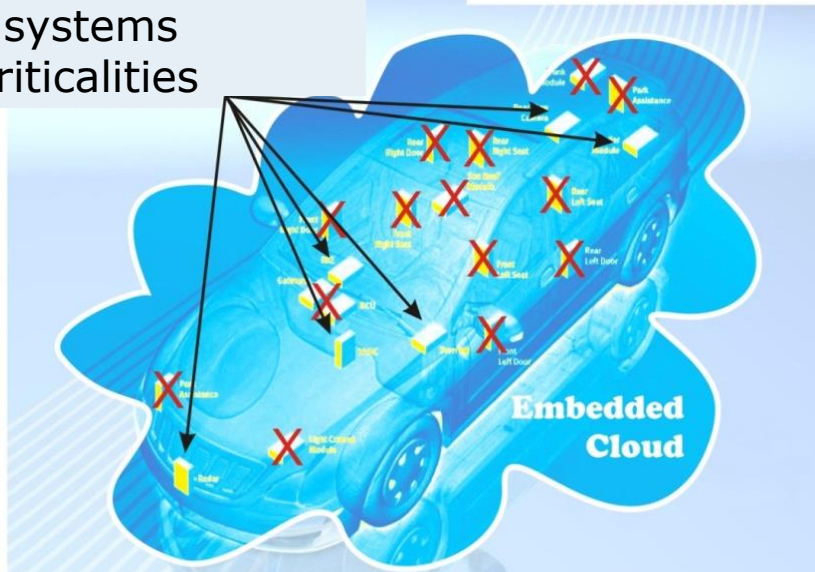

Offer system proper-
ties as services and
not as independent
systems

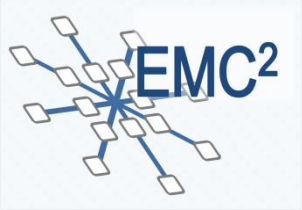

Cyberphysical System: Criticality, Complexity and Dynamics in Embedded Systems



State of the art in Criticality:

- Handle different tasks in separate hardware

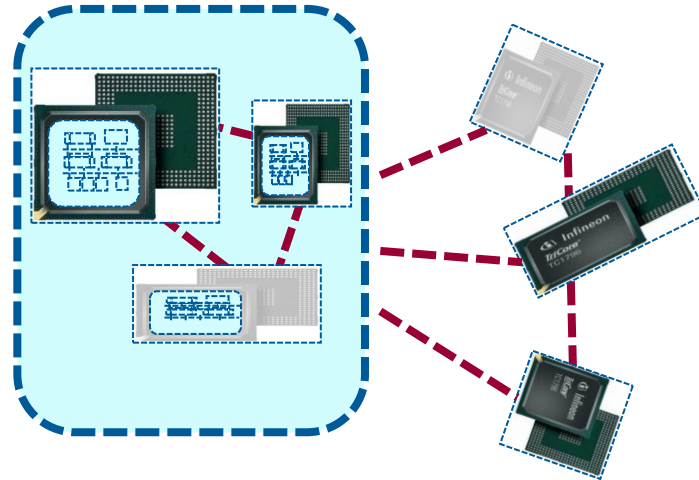

State of the art in Complexity and Dynamics:

- known number of control units and applications
- test before runtime
- Static scheduling of tasks, no dynamic changes at runtime

EMC² Goals:

- Handle mixed critical applications on one single die

EMC² Goals

- variable number of control units and unknown applications possible
- full range of dynamic changes possible

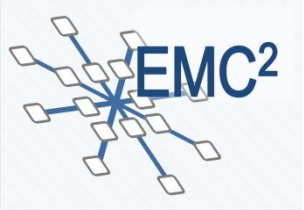

Technological innovation



- Mixed Criticality
 - Handle applications with different priorities
- Dynamic Re-configuration
 - Full range of dynamic changes on application level
- Hardware Complexity
 - Variable number of control units at runtime

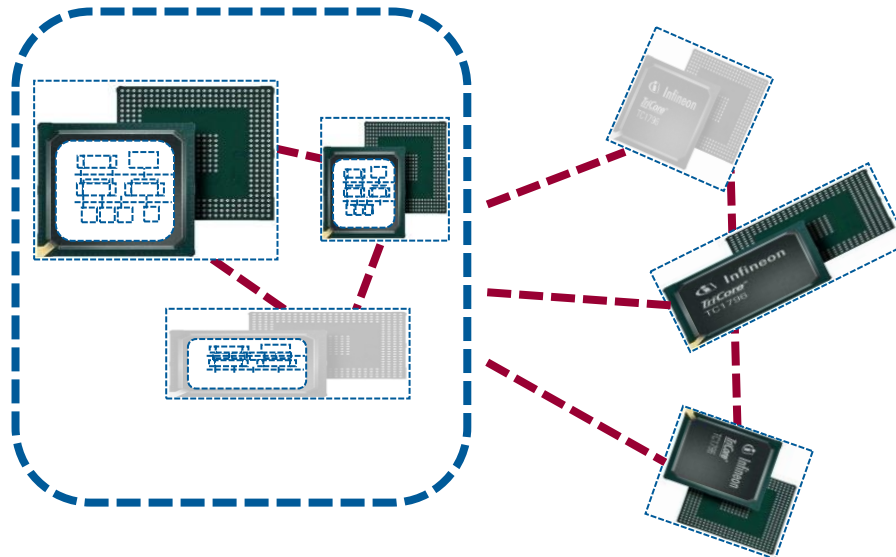

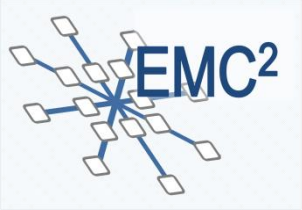

Economic Impact of EMC²



High impact of embedded systems to ***support and drive the innovation*** in many important market sectors:

- **Automotive:** key sector for the European economy, 12 million jobs, 26 billion annual invest in R&D by European car manufacturers; positive contribution to trade balance of € 90 billion p.a.; ***embedded systems enable >90% of innovations.***
- **Industrial control and factory automation:** revenue of 16.5 B€; 30% of energy consumed in the world is used for electric motors. ***Large potential for energy saving;***
- **Healthcare:** represents 25% of the EU economy; Challenges related to ***improving efficiency and effectiveness*** of healthcare

➔ **Multicore technology as enabler
for driving the innovation!**

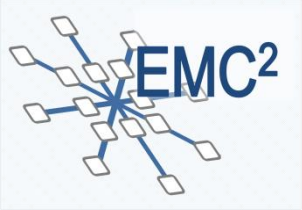

EMC² a large-size project



Large Size **platform project EMC²**
encourages and catalyzes new consortia on EU level
for product-oriented and successive funded projects

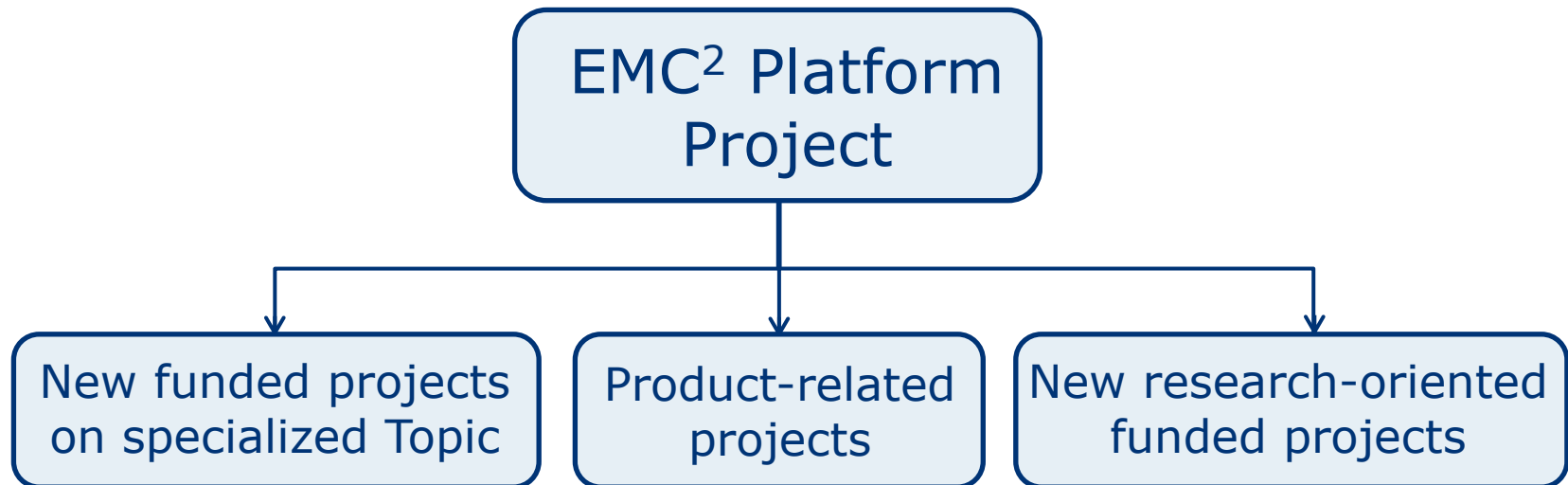

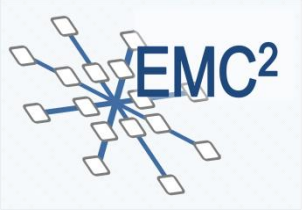

Project Management



- A project of this size can be technically managed although it requires significant dedication
- Project Management cares for
 - the overall structure and organizational framework,
 - Contracts (GA, CA, Deliverables)
 - the point of external contact,
 - inter WP relations,
 - the homogeneous look of the project
- A certain degree of de-centralization is necessary: two levels: WP management level; partner level
 - All demos developed on the level of a few partners

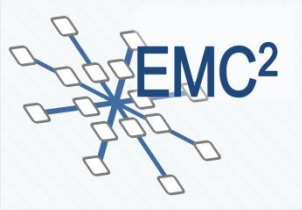

Bracket between WPs in EMC²

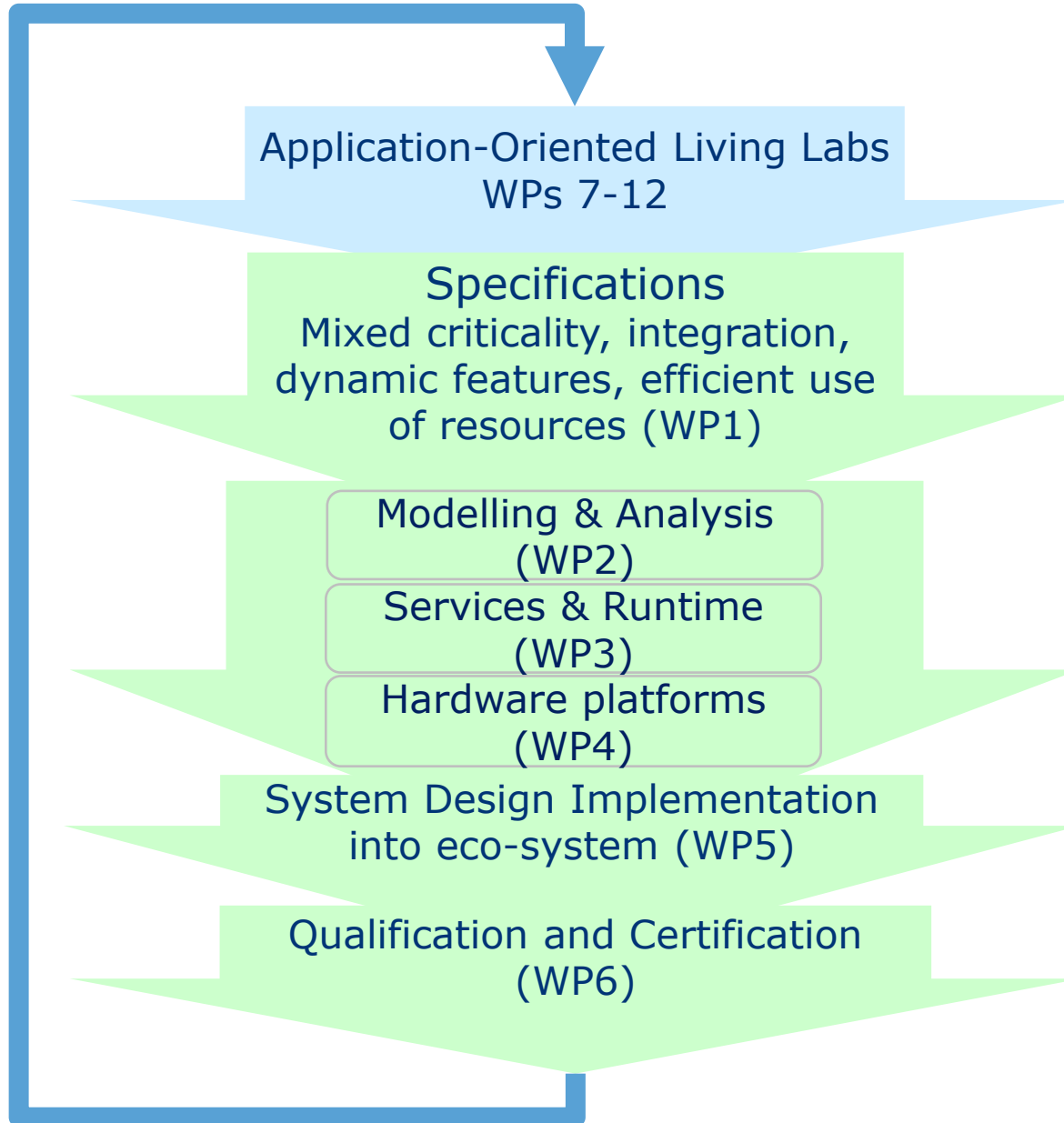

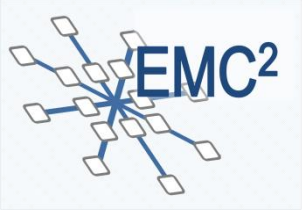

Application and technology innovation oriented WP structure



➤ Technology innovation oriented work packages

- WP1: SoA - Embedded system architecture
- WP2: Executable Application Models and Design Tools for Mixed-Critical, Multi-Core Embedded Systems
- WP3: Dynamic runtime environments and services
- WP4: Multi-core hardware architectures and concepts
- WP5: System design platform, tools, models and interoperability
- WP6: System qualification and certification

➤ Application innovation oriented WPs (Living Labs)

- WP7: Automotive
- WP8: Avionics
- WP9: Space applications
- WP10: Industrial manufacturing
- WP11: Internet of things
- WP12: Cross domain applications

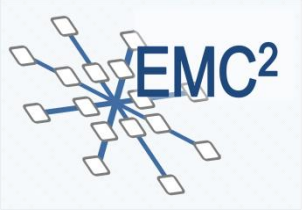

What is unique about EMC²?

- All domains: Home Automation through Automatic Driving
- All areas: Sea, Land, Air and Space
- All driven by Embedded Computing
- All running a mix of applications
- All using Multi-Core ...
... but so far nobody knows how.

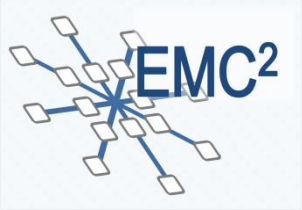

Application innovation



- EMC² - Embedded Multi-core Systems for Mixed-Criticality Applications in Dynamic and Changeable Real-Time Environments
- Applications: Automotive, Avionics, Space, Industry, Health care; Infrastructure
- Improve performance, lower cost
- Improve energy efficiency



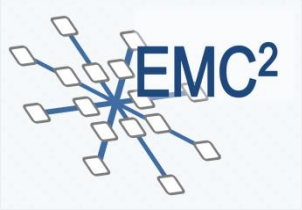

Application Topics in EMC²



- Automotive
- Avionics
- Space
- Industrial manufacturing
- Logistics
- IT-infrastructure ('Internet of Things')
- Healthcare
- Railway
- Seismic surveying



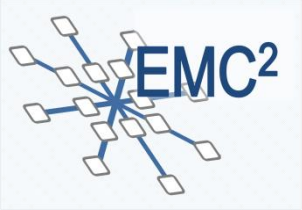

Application Topics in EMC²



- **Automotive**
- Avionics
- Space
- Industrial manufacturing
- Logistics
- IT-infrastructure ('Internet of Things')
- **Healthcare**
- Railway
- **Seismic surveying**



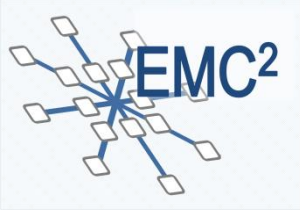

EMC² - Medical Imaging (Philips, TNO, Vector Fabrics, TUDelft)



Objective / Scope

- Today: problems in data acquisition not visible to the operator in examination room → often rescan needed.
- Prevented when multiple mixed-critical systems are combined on hardware level.
- Challenges to manage mixed-criticality

Project Goals

- Reduce number of systems
- Bring reconstruction and post-processing into examination room

Exploitation

- Prevent patient recall
- Reduce hardware and maintenance cost

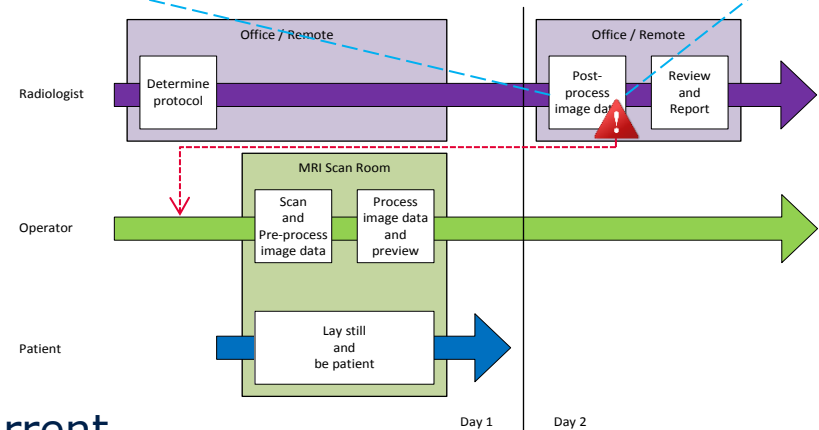
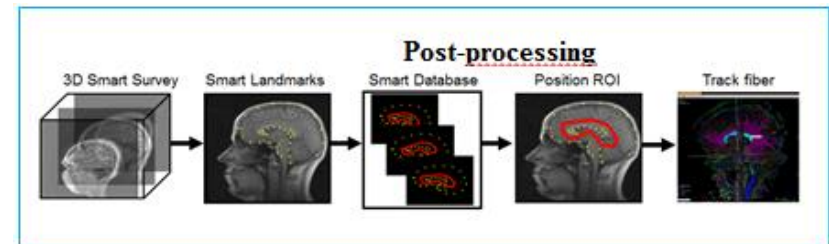

Current EMC²

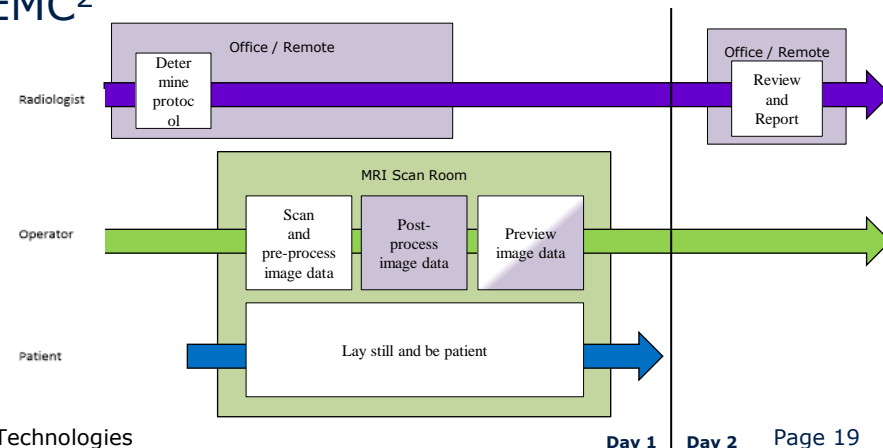

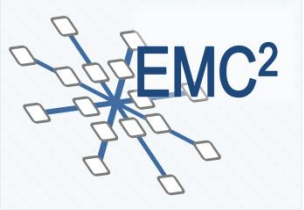

EMC² Seismic processing

(WesternGeco, Simula, U. Oslo, Fornebu, KTH)



Purpose: Produce images of geological features and their structure below the surface of the earth

On sea:

- Networked computers
 - In the streamers > 2 000 computers
 - Onboard the ship > 200 computers
- Compute power > 2 Tflops
- Number of sensors > 200 000
- Huge Data rate 1-3 Gbit/s
- Disk capacity > 100 Tbytes

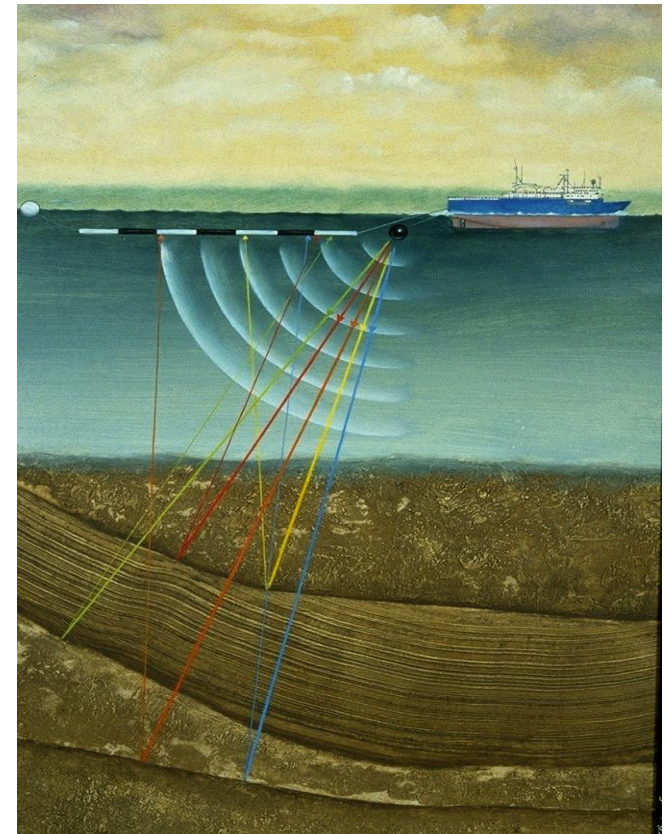

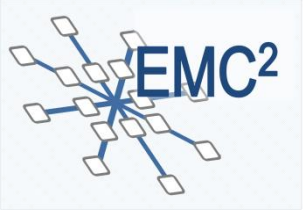

EMC² Seismic processing

(WesternGeco, Simula, U. Oslo, Fornebu, KTH)



Real-time processing on sea:

300
Mbit/sec
per streamer

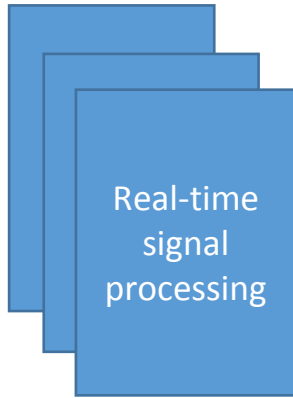
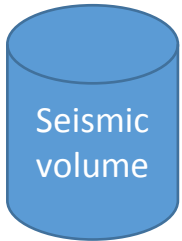

Real-time
signal
processing

300
Mbit/sec
per
streamer



On ship:

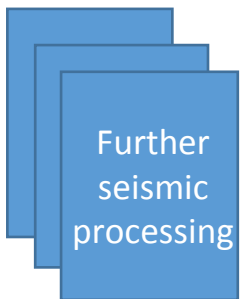

Further
seismic
processing



On land:

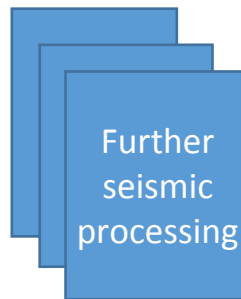

Further
seismic
processing

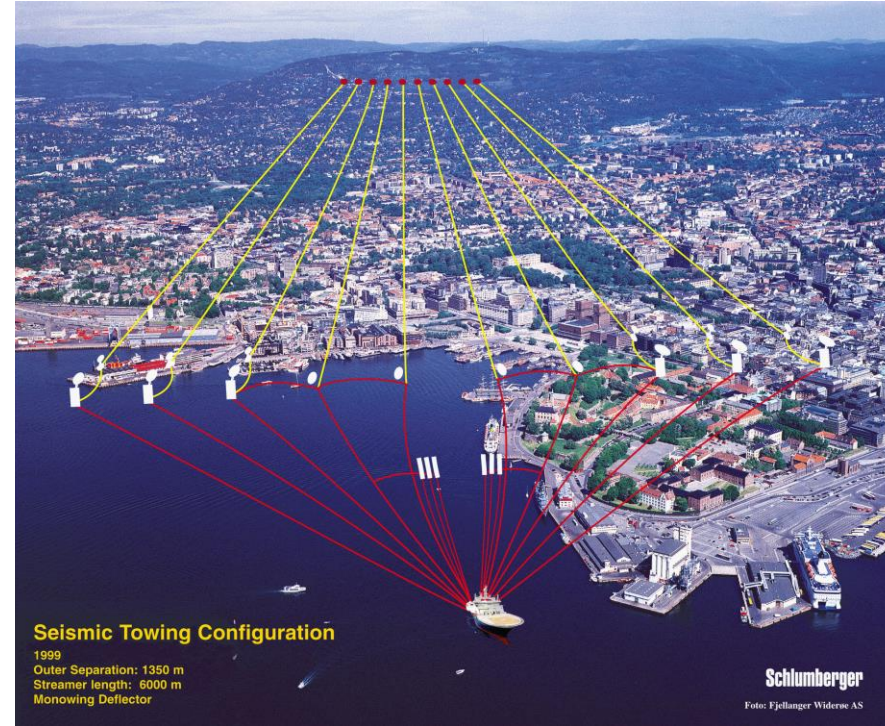

200 computers with 4 000 cores



8-14 streamers behind ship
Streamer length 10km - 14 km
100 - 200 computers per streamer
200 000 sensors per streamer

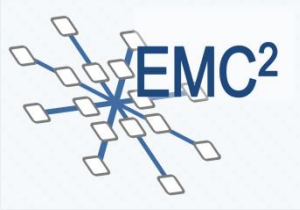

Public project website



- First version online at project start: www.emc2-project.eu
- New and significantly extended version online since beginning of July 2014: www.artemis-emc2.eu
- Website is updated whenever news, events and other information for publication becomes available (latest update after finalisation of the 2nd EMC² Newsletter)

EMBEDDED MULTI-CORE SYSTEMS FOR MIXED CRITICALITY APPLICATIONS IN DYNAMIC AND CHANGEABLE REAL-TIME ENVIRONMENTS

Search OK

NEWS EVENTS PROJECT OVERVIEW PARTNERS & AUTHORITIES PUBLICATIONS CONTACT IMPRINT

About EMC²

EMC² – ‘Embedded Multi-Core systems for Mixed Criticality applications in dynamic and changeable real-time environments’ is an ARTEMIS Joint Undertaking project in the Innovation Pilot Programme ‘Computing platforms for embedded systems’ (AIPP5).

Embedded systems are the key innovation driver to improve almost all mechatronic products with cheaper and even new functionalities. They support today’s information society as inter-system communication enabler. A major industrial challenge arises from the need to face cost efficient integration of different applications with different levels of safety and security on a single computing platform in an open context.

EMC² finds solutions for dynamic adaptability in open systems, provides handling of mixed criticality applications under real-time conditions, scalability and utmost flexibility, full scale deployment and management of integrated tool chains, through the entire lifecycle.

The objective of EMC² is to establish Multi-Core technology in all relevant Embedded Systems domains.

Upcoming Events

06/22/2015

EMC² Special Session at IEEE INDIN Conference 2015

EMC² IEEE Industrial Informatics Conference (INDIN) 2015 - special session on “Embedded Multi-Core Systems for Mixed Criticality Applications in...”

[Read more](#)

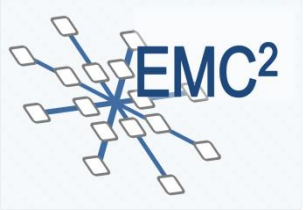

Work Plan

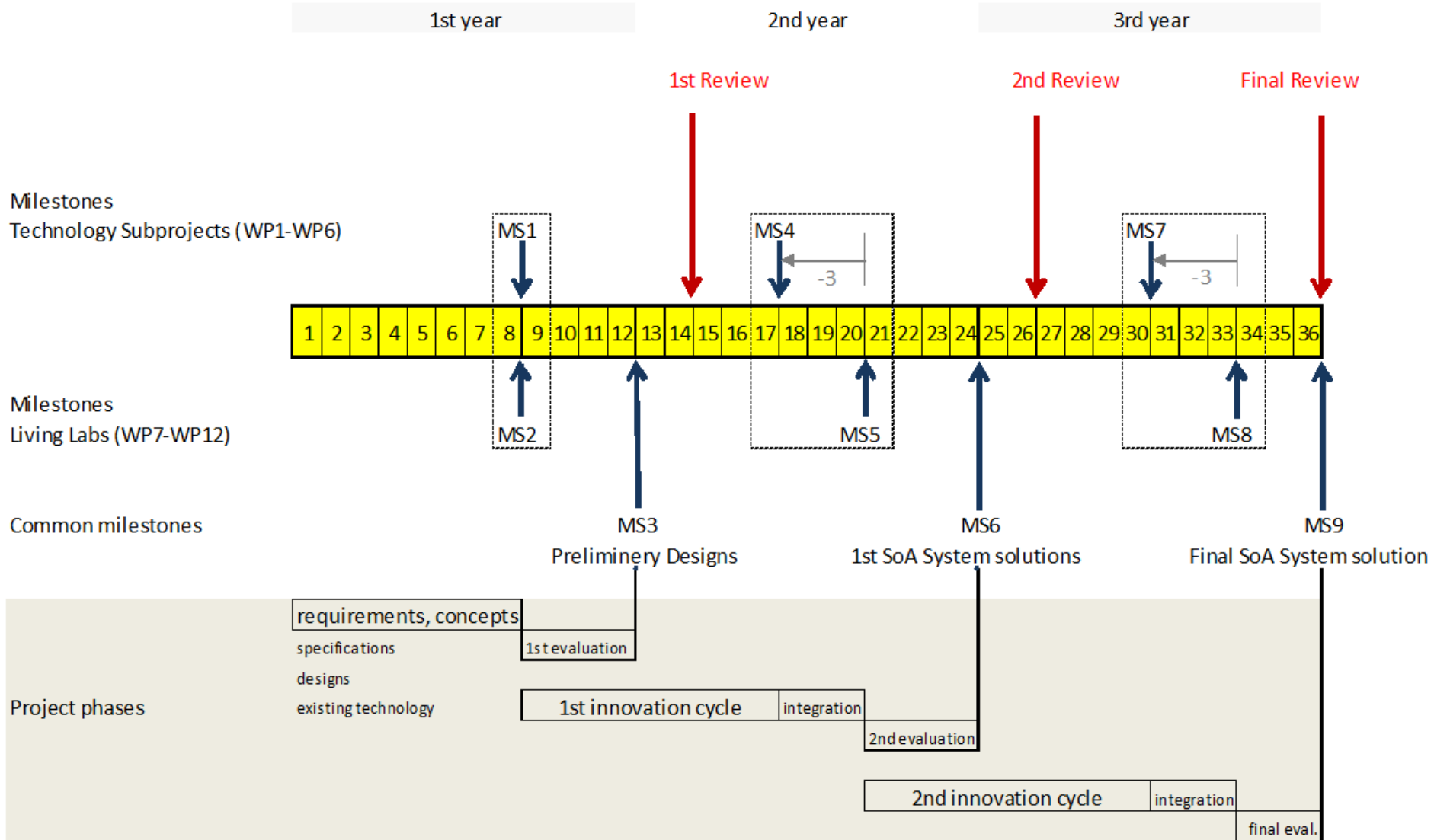

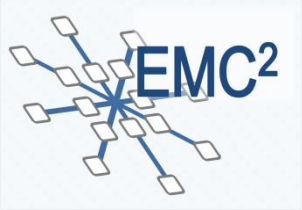

Project monitoring: Milestones MS1, MS2, MS3 achieved

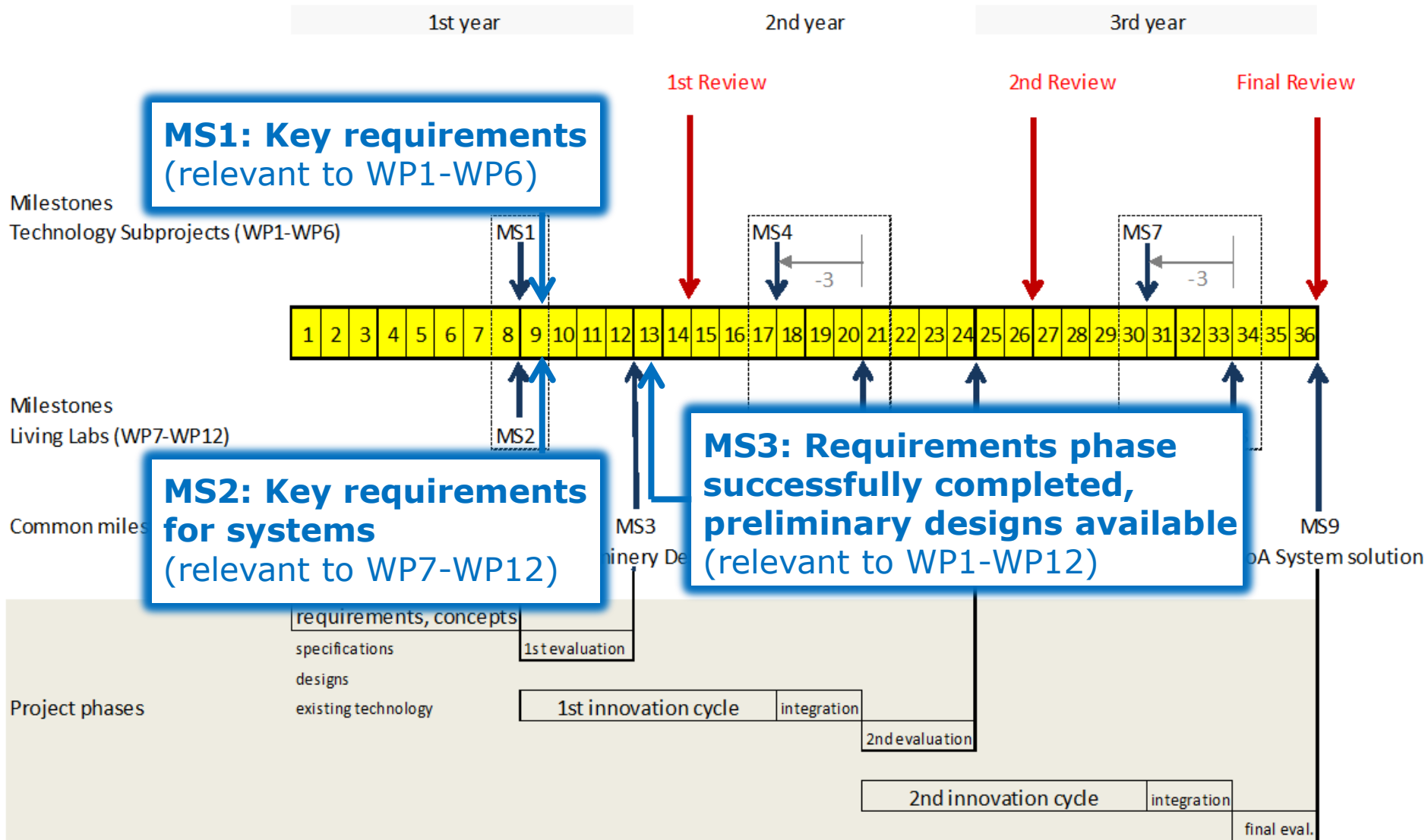

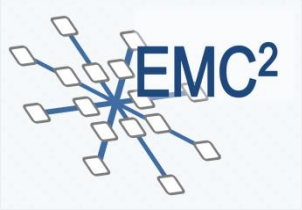

Conclusion



- Project Ramp-up and specification phase successfully completed
- Project on track
 - all deliverables available
 - milestones MS1, MS2, MS3 achieved
 - minor delay compared to plan; likely to be recovered during P2 and P3
- Now project heads for implementation of preliminary designs

